

MUNDIAL

INDUSTRIAL PLUGS AND SOCKETS

Description: IP44 COMBO SOCKET 3P+N+E 380V 32A 6H

Reference:

00316

Characteristics:

Product type:	Combo socket
Current:	32A
Poles:	3P+N+E
Voltage:	200/346 - 240/415 V
Frecuency(Hz):	-
Time code:	6
Colour:	Red
Weight (kg):	2,21
Dimensions:	
Materials:	Halogen-free plastic materials. Plastic parts: polyamide 6. Contacts: copper-zinc alloy
Packaging units:	5

Technical data:

Degree of protection:	IP44
Degree of protection remarks:	
Resistance to impact:	IK08
Glow wire resistance:	960 °C
Ball pressure test:	125 °C
Ambient temperature range:	-25 °C / +40 °C

Certifications and norms:

Directive:	2014/35/EU
Standards:	IEC 60884-1
Certificates:	



Codes:

EAN:	8431044003160
Customs tariff number:	85.36.69.90
ETIM 8.0:	EC004118

MUNDIAL

INDUSTRIAL PLUGS AND SOCKETS

Description: IP44 COMBO SOCKET 3P+N+E 380V 32A 6H

Reference: 00316

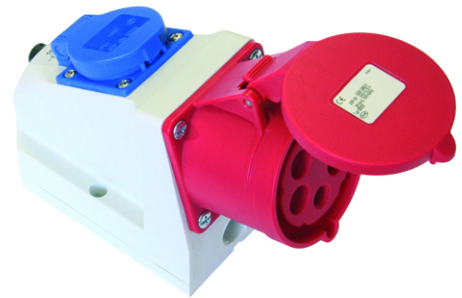
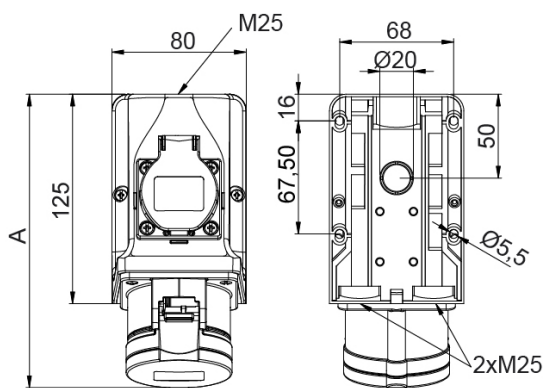

Dimensions:

I	Poles	Dimensions		
		A	B	M
16 A	2P+E	175	127	3X25
	3P+E	176	130	3X25
	3P+N+E	176	133	3X25
32A	2P+E	188	136	3X25
	3P+E	188	136	3X25
	3P+N+E	188	141	3X25

Sustainability:

RoHS - REACH

Product end of life stage:

Product concerned in the WEEE regulations.

Supply:

Supplied in a single box per packaging multiple