

MUNDIAL

INDUSTRIAL PLUGS AND SOCKETS

Description: IP66-IP67 WALL SOCKET 3P+E 380V 63A 6H

Reference:

03872

Characteristics:

Product type:	Low voltage wall socket
Current:	63A
Poles:	3P+E
Voltage:	380/415 V
Frecuency(Hz):	-
Time code:	6
Colour:	Red
Weight (kg):	1,90
Dimensions:	
Materials:	Halogen-free plastic materials. Plastic parts: polyamide 6. Contacts: copper-zinc alloy
Packaging units:	2

Technical data:

Degree of protection:	IP66-IP67
Degree of protection remarks:	
Resistance to impact:	IK08
Glow wire resistance:	960 °C
Ball pressure test:	125 °C
Ambient temperature range:	-25 °C / +40 °C

Certifications and norms:

Directive:	2014/35/EU
Standards:	IEC 60309-1-2
Certificates:	



Codes:

EAN:	8431044038728
Customs tariff number:	85.36.69.90
ETIM 8.0:	EC001321

MUNDIAL

INDUSTRIAL PLUGS AND SOCKETS

Description: IP66-IP67 WALL SOCKET 3P+E 380V 63A 6H

Reference: 03872

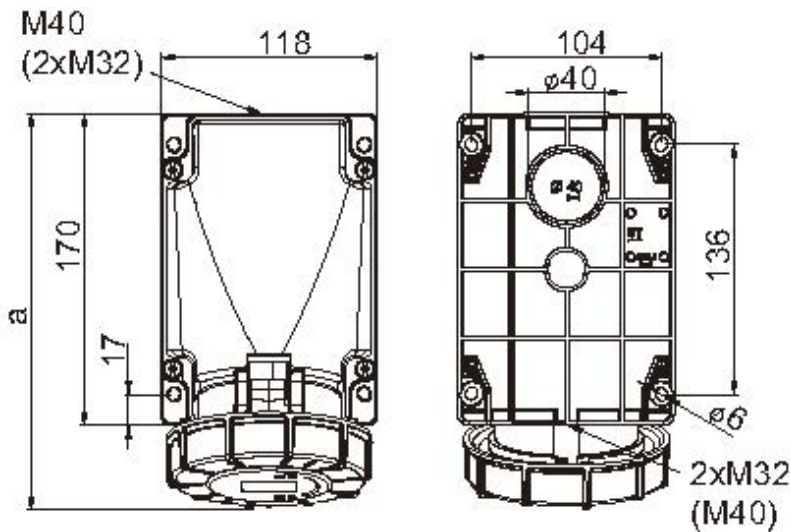

Dimensions:

I	Poles	Dimensions												
		A	B	C	D	E	F	G	H	I	J	K	L	M
16 A	2P+E	100	117	10	88	90	53.6	76.6	40	87	69	8	5	M25x1.5
	3P+E	100	117	10	88	95	53.6	76.6	40	87	77	8	5	M25x1.5
	3P+N+E	118	135	10	99	108	71.6	76.6	43	101	89	8	5	M25x1.5
32A	2P+E	118	140	10	99	108	71.6	90.6	43	101	89	8	5	M25x1.5
	3P+E	118	140	10	99	108	71.6	90.6	43	101	89	8	5	M25x1.5
	3P+N+E	118	140	10	99	111	71.6	90.6	43	101	98	8	5	M25x1.5
63 A	2P+E	170	213	-	-	173	104	-	136	118	-	-	6	M40+2xM32
	3P+E	170	213	-	-	173	104	-	136	118	-	-	6	M40+2xM32
	3P+N+E	170	213	-	-	173	104	-	136	118	-	-	6	M40+2xM32
125A	2P+E	262	322	-	-	205	140	-	240	162	-	-	8	M63+2xM40
	3P+E	262	322	-	-	205	140	-	240	162	-	-	8	M63+2xM40
	3P+N+E	262	322	-	-	205	140	-	240	162	-	-	8	M63+2xM40

Sustainability:

RoHS - REACH

Product end of life stage:

Product concerned in the WEEE regulations.

Supply:

Supplied in a single box per packaging multiple