

ORO

IP40 FLUSH-FIT DISTRIBUTION BOXES

Description: IP40 FLUSH-FIT BOX 1x4 MOD. TRANSPARENT WINDOW. N&E BARS

Reference:
BM4PT/RR

Characteristics:

Product type:	Flush-fit distribution boxes with neutral and earth bars
Exterior dimensions (Height x Width x Depth):	228x120x97 mm
Dimensions of the flush-fit gap (HxWxD):	228x120x65 mm
Number of modules:	1x4 DIN rail
Installation:	Flush-fitted
Color:	RAL 9003
Window:	Transparent
Weight (kg):	0,44
Cable entry:	Top: 2xM25-1xM25/32. Bottom: 2xM25-1xM25/32. Left: 2xM25. Right: 2xM25
Components:	Cable section N&E: 2x(4-10mm ²)+4x(2,5-6 mm ²)
Materials:	Halogen-free plastic materials. Polystyrene
Lid-window-door material:	Tinted PC

Technical data:

Degree of protection:	IP40
Resistance to impact:	IK08
Glow wire resistance:	650 °C
Ball pressure test:	70 °C
Ambient temperature range:	-25 °C / +40 °C
Maximum operating voltage:	1000 V AC / 1500 V DC
Rated current:	63A
Double insulation:	Class II

Certificates and standards:

Directive:	2014/35/EU
Standards:	IEC 62208, IEC 61439-1
Certificates:	



Codes:

EAN:	8431044301525
Customs tariff number:	85.38.10.00
ETIM 8.0:	EC000214

ORO

IP40 FLUSH-FIT DISTRIBUTION BOXES

Description: IP40 FLUSH-FIT BOX 1x4 MOD. TRANSPARENT WINDOW. N&E BARS

Reference: BM4PT/RR

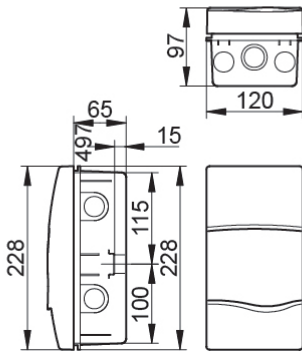

Exterior dimensions (Height x Width x Depth):

228x120x97 mm

Dimensions of the flush-fit gap (Height x Width x Depth):

228x120x65 mm

Sustainability:

RoHS - REACH

Supply:

Supplied in individual cardboard packaging. When several items are sent together, they are bundled together with transparent film.

Packaging units: 12

Product end of life:

It does not require specific recycling operations.

Recommended applications:

Tertiary and residential sectors. For use indoors, designed for flush-fit installation. Flats, houses, offices, hotels, etc.