

Susol Molded Case Circuit Breaker TS160N



General

Product code	0105015100
Product description	TS160N FMU160 160A 3P EXP
Trip Unit	FMU(Adjustable-thermal, Fixed-magnetic)
[In] rated current	160 A at 40 °C
Poles description	3P
Protected poles description	3T
Neutral position	-
Network type	AC (50/60 Hz), DC
Upside connection	Front (screw)
Downside connection	Front (screw)

Characteristics

[Ue] rated operational voltage (AC 50/60 Hz)	690 V AC
[Ue] rated operational voltage (DC)	500 V DC
[Uimp] rated impulse withstand voltage	8 kV
[Ui] rated insulation voltage	1000 V
Mechanical durability	25000 cycles
Electrical durability (AC)	10000 cycles 415 V In

Electrical durability (DC)	-
Utilisation category	Category A
Suitability for isolation	Yes
Reference standard	IEC 60947-2
[Icu] rated Ultimate short-circuit breaking capacity	100 kA at 220/240 V AC 50/60 Hz, IEC 60947-2
	50 kA at 380/415 V AC 50/60 Hz, IEC 60947-2
	50 kA at 440/460 V AC 50/60 Hz, IEC 60947-2
	42 kA at 480/500 V AC 50/60 Hz, IEC 60947-2
	22 kA at 525 V AC 50/60 Hz, IEC 60947-2
	10 kA at 660/690 V AC 50/60 Hz, IEC 60947-2
	50 kA at 250 V DC, Reference
	50 kA at 500 V DC (2poles in series), Reference
[Ics] rated service breaking capacity	100 kA at 220/240 V AC 50/60 Hz, IEC 60947-2
	50 kA at 380/415 V AC 50/60 Hz, IEC 60947-2
	50 kA at 440/460 V AC 50/60 Hz, IEC 60947-2
	42 kA at 480/500 V AC 50/60 Hz, IEC 60947-2
	22 kA at 525 V AC 50/60 Hz, IEC 60947-2
	5 kA at 660/690 V AC 50/60 Hz, IEC 60947-2
	50 kA at 250 V DC, Reference
	50 kA at 500 V DC (2poles in series), Reference
[Icm] rated short-circuit marking capacity	220 kA at 220/240 V AC 50/60 Hz, IEC 60947-2
	105 kA at 380/415 V AC 50/60 Hz, IEC 60947-2
	105 kA at 440/460 V AC 50/60 Hz, IEC 60947-2
	88 kA at 480/500 V AC 50/60 Hz, IEC 60947-2
	46 kA at 525 V AC 50/60 Hz, IEC 60947-2
	17 kA at 660/690 V AC 50/60 Hz, IEC 60947-2
[Icw] rated short-time	-
	-
	-

withstand current	-
	-
Trip unit characteristics	Thermal-magnetic
	L : for overload protection (long time)
	-
	I : for instantaneous short-circuit protection
	-
	-
	-
	-
[Ir] Long-time pick-up adjustment range	Adjustable, 3 settings
	0.8, 0.9, 1 x In
[Iu] Long-time pick-up adjustment range	-
	-
[tr] Long-time delay adjustment range	-
	-
[Isd] Short-time pick-up adjustment range	-
	-
[tsd] Short-time delay adjustment range	-
	-
	-
	-
	-
	-
[Ii] Instantaneous pick-up	Fixed

Mounting mode	Fixed
Mounting support	Backplate
Approvals ¹⁾ (General)	CE (Europe)
	-
	-
	CCC (China)
	EAC (Russia)
	IC (Korea)
Approvals (shipping)	LR (U.K)
	BV (France)
	ABS (U.S.A)
	GL (Germany)
	DNV (Norway)
	RINA (Italy)
	KR (Korea)

1) LS ELECTRIC's standard products are designed for CE.

To check the product with regional certificates, please contact LSE sales representatives.

Dimensions

Product	Width	105 mm
	Height	160 mm
	Depth	86 mm
	Weight	2 kg
Packing	Width	335 mm
	Height	565 mm
	Depth	132 mm
	Weight	20 kg
	Quantity (in a box)	10 pcs.

TS100/160/250

[mm]

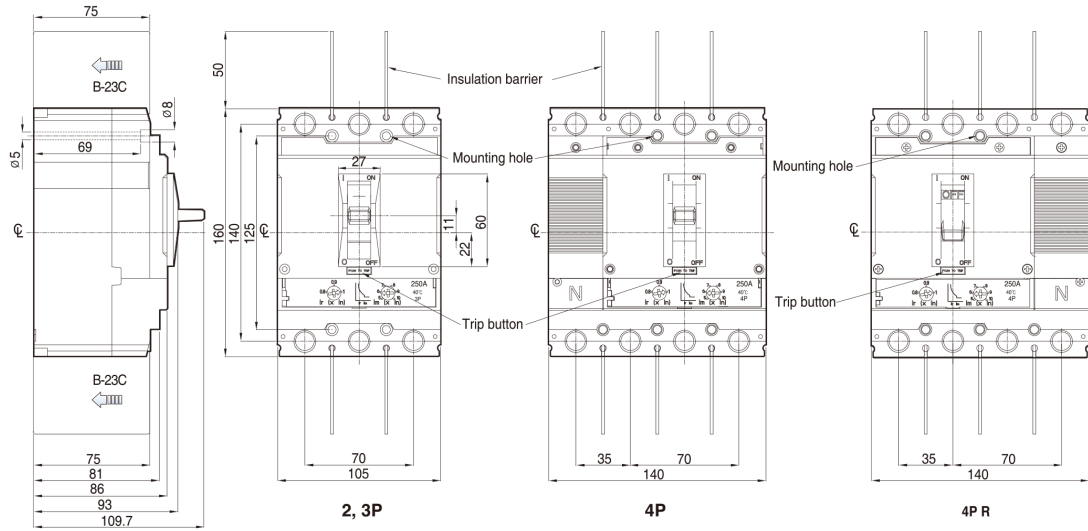

Terminal section



Conductor

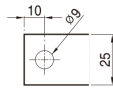

Panel drilling

Front panel cutting

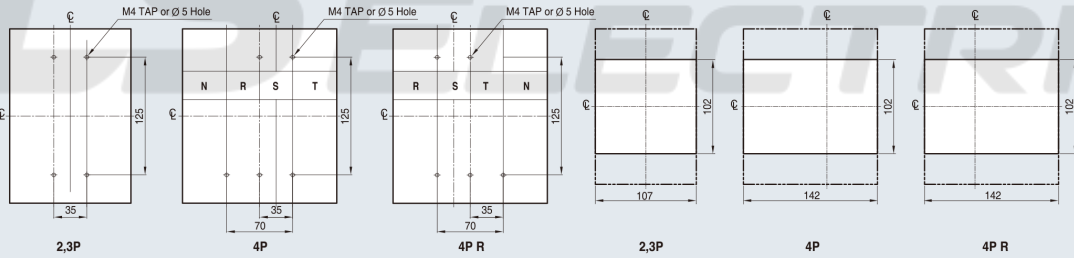

LS ***ELECTRIC***