

Susol Molded Case Circuit Breaker

TE100S



General

Product code	0161003400
Product description	TE100S FMU100 16A 3P EXP
Trip Unit	FMU(Adjustable-thermal, Fixed-magnetic)
[In] rated current	16 A at 40 °C
Poles description	3P
Protected poles description	3T
Neutral position	-
Network type	AC (50/60 Hz), DC
Upside connection	Front (lug)
Downside connection	Front (lug)

Characteristics

[Ue] rated operational voltage (AC 50/60 Hz)	690 V AC
[Ue] rated operational voltage (DC)	500 V DC
[Uimp] rated impulse withstand voltage	8 kV
[Ui] rated insulation voltage	750 V
Mechanical durability	25000 cycles
Electrical durability (AC)	10000 cycles 415 V In

Electrical durability (DC)	-
Utilisation category	Category A
Suitability for isolation	Yes
Reference standard	IEC 60947-2
[Icu] rated Ultimate short-circuit breaking capacity	50 kA at 220/240 V AC 50/60 Hz, IEC 60947-2
	37 kA at 380/415 V AC 50/60 Hz, IEC 60947-2
	25 kA at 440/460 V AC 50/60 Hz, IEC 60947-2
	18 kA at 480/500 V AC 50/60 Hz, IEC 60947-2
	-
	6 kA at 660/690 V AC 50/60 Hz, Reference
	37 kA at 250 V DC, Reference
	37 kA at 500 V DC (2poles in series), Reference
[Ics] rated service breaking capacity	50 kA at 220/240 V AC 50/60 Hz, IEC 60947-2
	37 kA at 380/415 V AC 50/60 Hz, IEC 60947-2
	25 kA at 440/460 V AC 50/60 Hz, IEC 60947-2
	18 kA at 480/500 V AC 50/60 Hz, IEC 60947-2
	-
	-
	37 kA at 250 V DC, Reference
	37 kA at 500 V DC (2poles in series), Reference
[Icm] rated short-circuit marking capacity	105 kA at 220/240 V AC 50/60 Hz, IEC 60947-2
	77.7 kA at 380/415 V AC 50/60 Hz, IEC 60947-2
	52.5 kA at 440/460 V AC 50/60 Hz, IEC 60947-2
	36 kA at 480/500 V AC 50/60 Hz, IEC 60947-2
	-
	9.2 kA at 660/690 V AC 50/60 Hz, Reference
[Icw] rated short-time	-
	-
	-

withstand current	-
	-
Trip unit characteristics	Thermal-magnetic
	L : for overload protection (long time)
	-
	I : for instantaneous short-circuit protection
	-
	-
	-
	-
[Ir] Long-time pick-up adjustment range	Adjustable, 3 settings
	0.8, 0.9, 1 x In
[Iu] Long-time pick-up adjustment range	-
	-
[tr] Long-time delay adjustment range	-
	-
[Isd] Short-time pick-up adjustment range	-
	-
[tsd] Short-time delay adjustment range	-
	-
	-
	-
	-
	-
[Ii] Instantaneous pick-up	Fixed
	-

adjustment range	400 A
[Ig] Ground-fault protection pick-up adjustment range	-
	-
[tg] Ground-fault protection time delay adjustment range	-
	-
	-
	-
	-
	-
Earth leakage pick-up adjustment range	-
	-
Earth leakage alarm time delay adjustment range	-
	-
Earth leakage trip time delay adjustment range	-
	-
[Ip] Pre-trip alarm pick-up adjustment range	-
	-
[tp] Pre-trip alarm time delay adjustment range	-
	-
Alarm LED	-
	-

Environment

Pollution degree	3, IEC 60664-1
Degree of protection	IP20, IEC 60529
Ambient air temperature for operation	-20...70 °C
Ambient air temperature for storage	-40...70 °C

Mounting mode	Fixed
Mounting support	Backplate
Approvals ¹⁾ (General)	CE (Europe)
	-
	-
	-
	EAC (Russia)
	-
Approvals (shipping)	-
	-
	-
	-
	-
	-
	-

1) LS ELECTRIC's standard products are designed for CE.

To check the product with regional certificates, please contact LSE sales representatives.



Dimensions

Product	Width	76 mm
	Height	130 mm
	Depth	82 mm
	Weight	1.05 kg
Packing	Width	289 mm
	Height	442 mm
	Depth	120 mm
	Weight	12 kg
	Quantity (in a box)	10 pcs.

TE100/160

[mm]

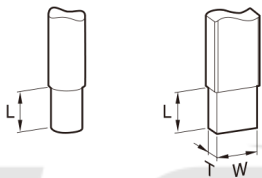
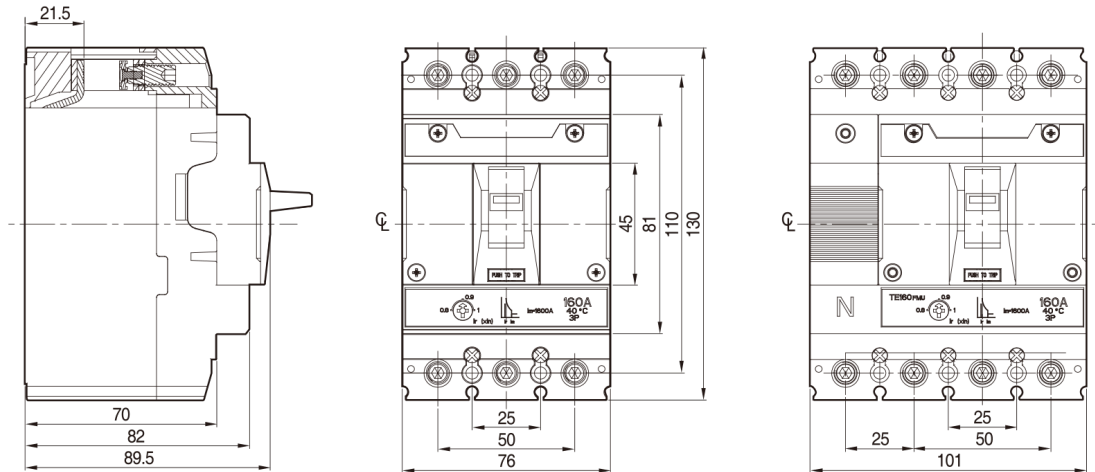

Wire size	Min.	2.5mm ²
	Max.	70mm ²
L(mm)	17.5	
W(mm)	≤ 13.5	
T(mm)	≤ 6	
Torque	80kgf.cm	

LS ELECTRIC

Panel drilling

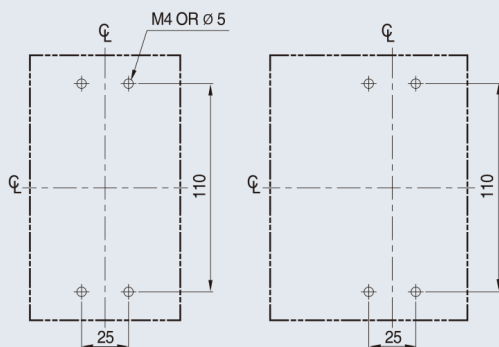

Front panel cutting

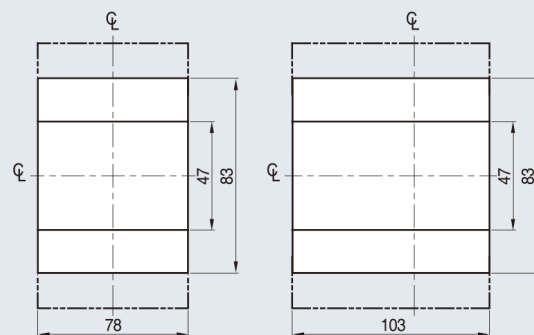

***LS* ELECTRIC**