

# S5B

## Bypass changeover switch

### base mounting 3P - 3P+N

Size 2  
A 500|630



series  
**S5B**

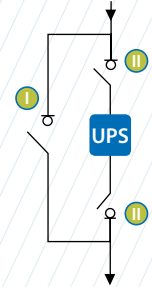

	CODE-500A	CODE-630A
3P	<b>S5B05003PR0</b>	<b>S5B06303PR0</b>
3P + N	<b>S5B05003NR0</b>	<b>S5B06303NR0</b>

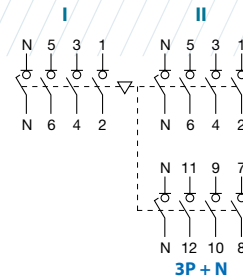
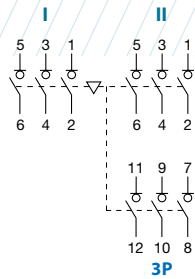

### Technical information



According to IEC 60947-3

				500	630
Rated thermal current	I <sub>th</sub>	in ambient at 40° C	A	500	630
Rated insulation voltage	U <sub>i</sub>		V	1000	1000
Rated impulse withstand voltage	U <sub>imp</sub>		kV	12	12
AC Rated operational current <sup>*(1)</sup>	I <sub>e</sub>	U <sub>e</sub> 400V AC21A	A	500	630
(Rated operational frequency 50/60 Hz)		U <sub>e</sub> 400V AC22A	A	500	630

<sup>\*(1)</sup> Other voltages and/or utilization categories; please consult

<sup>\*(2)</sup> Without limiting protective device (short - circuit maintained 50 ms. - 100 ms.)

				500	630
Rated breaking capacity	400V	AC22	A	1500	1890
Rated making capacity	400V	AC22	A	1500	1890
<b>Short - circuit behaviour</b>					
Short - circuit making capacity <sup>*(2)</sup>	I <sub>cm</sub>	kA (peak)		26	26
Short - time withstand current (1 sec.)	I <sub>cw</sub>	kA rms		16	16
Number of mechanical operations (according to the standards, for other values please consult)		Cycles		5000	5000
Number of electrical operations	400V	AC22A	Cycles	1000	1000
Maximum weight (3/4 poles)			Kg	16,5/17,5	16,5/17,5

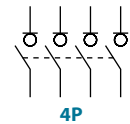
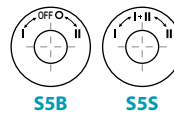

There are versions of bypass changeover without OFF 0 position "overlapped contacts":

Also available 4P changeover switches under request, please consult

S5B (I - I + II - II) = S5S \_\_\_\_\_, please consult



Accessories



» Direct handle

CODE D5LLI22



» Terminal shrouds

CODE DS-CU21  
(1 kit for input or output only front side)

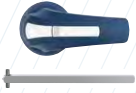

» External handle included shaft\*(e1)

IP65  
CODE D5LLA21

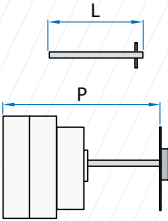

» Shafts

Standard shaft included \*(e1)  
L (mm) | P (mm)  
239 | 448... 613



» Auxiliary contacts

1NO+1NC CODE DS-AU11  
2NO+2NC CODE DS-AU12

Ie = 16 A (resistive loads)  
4 A (inductive loads) at 250 Vac.

» Safety key lock device

Simple CODE D5LCB21  
Double CODE D5LCF21

For external handle, lock the handle by means of a key in position "OFF" (under request, in "ON"), the key can only be removed with the handle locked

Door drilling for handle and key lock device

Simple

Double

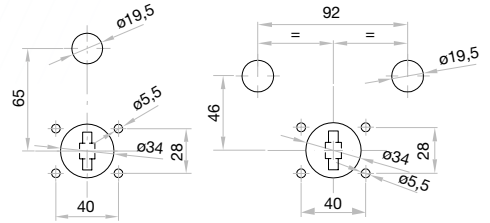

Dimensions (mm)

Door drilling for external handle

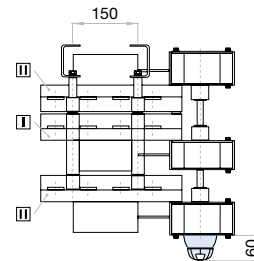
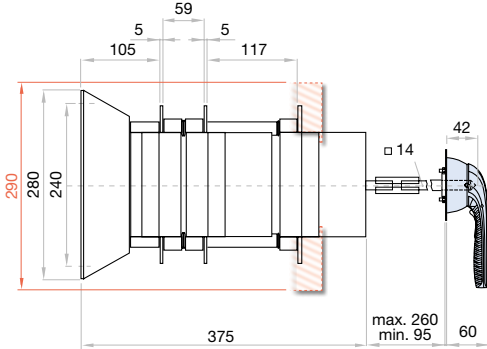
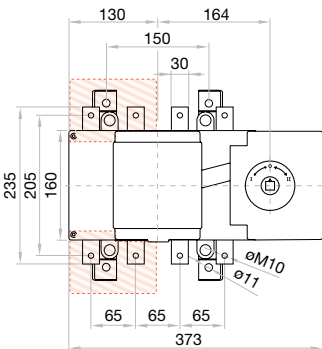
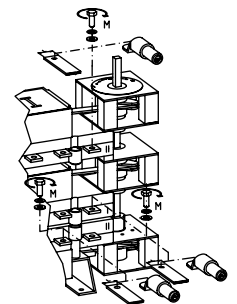
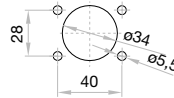

	S max (Cu)	H max (Cu)	L max (Cu)	T	M
	mm <sup>2</sup>	mm	mm		Nxm
500 A	2x185	6	40	M10	24

	S max (Cu)	H max (Cu)	L max (Cu)	T	M
	mm <sup>2</sup>	mm	mm		Nxm
630 A	2x240	2x5	40	M10	24