

A _ 12

A 1 12Z11

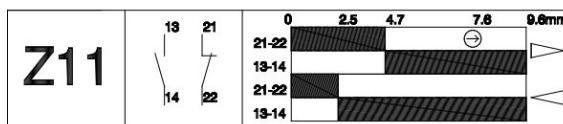

СТАТИЧНИЙ ЗД-ВИГЛЯД

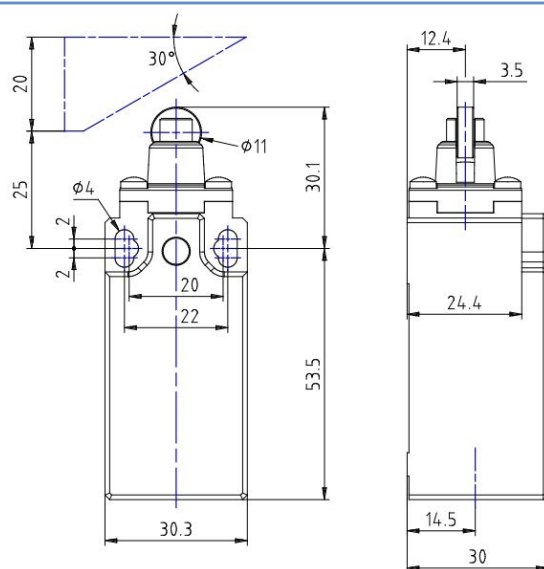
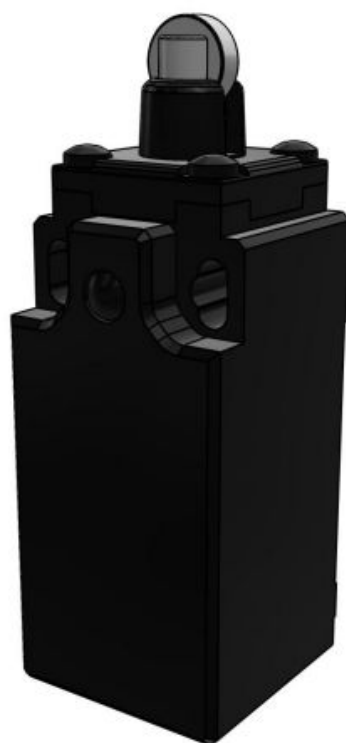

ДЕТАЛІ:

	A 1 12Z11
[]	30
,	PG13.5
IP	IP65 - 67
	(1 +1)
	IMQ - cULus - CCC - CSA - EAC
	LVD - 2014/35/
	IEC 60947-5-1 / EN 60947-5-1
[°C]	- 25°C ... +70°C
[°C]	-30°C ... +80°C
(IEC 60536) []	Class -
Ui []	500
	3
UL50	A600 - Q600
Uimp []	6
Ith [A (10
[A (Ue)]	10
Ie - AC-15 (50-60) [Secondo IEC 60947-5-1]	24 - 10 / 120 - 6 / 400 - 4
DC-13 [Secondo IEC 60947-5-1]	24 - 6 / 125 - 0,55 / 250 - 0,4
[Cicli/ora]	3600
[]	25
	M3.5 (+,-) pozidriv 2
[]	0,75 ... 2,5
	/
	IEC 60947-5-1
[]	15
B10d []	30

